



TERRASSENPLATTEN
EDITION 2023

CAV10241

2CM
PLATTENSTÄRKE

FLIESENINFO
Fliesenideen für alle Bereiche

VORTEILE & VERLEGEARTEN

Die große Auswahl an 2 cm starkem Feinsteinzeug ermöglicht Ihnen, die vielfältigen Vorteile der Keramik auch im Außenbereich für Ihre optimalen Lösungen zu nutzen.



DIE 2CM TERRASSENPLATTEN EIGNEN SICH HERVORRAGEND FÜR:

- Terrassen und Balkone (auch Sanierung über Altbestand)
- Dachterrassen (auf die Isolierung)
- Fußwege in Gärten
- Schwimmbad-Umrandungen
- Befahrbare Wege und Einfahrten
- Innenhöfe

VORTEILE GEGENÜBER ANDEREN TERRASSENBELÄGEN

- Leicht zu reinigen
- Langlebig und strapazierfähig
- Farb- und lichtecht
- Geringe Aufbauhöhe
- Vielfältige Farb- und Oberflächen Auswahl
- Frostbeständig
- Schnelle und einfache Verlegung
- Natürliche Rohstoffe
- Mit PKW befahrbar



Verschiedene Verlegetechniken ab Seite 64

INHALT

NATURSTEINOPTIK

NATURSTEINOPTIK

ALWAYS 60x60	CAV10113 • CAV10114 • CAV10115	2
ATAKAMA 60x60	MEI10068 • MEI10069 • MEI10070	4
BOLT 60x60	MEI10086 • MEI10087	6
CORNERSTONE 90x45	ERG10101 (ERG10108) • ERG10122 (ERG10102, ERG10105) • ERG10123 (ERG10103, ERG10109)	8
ECLIPSE 60x60 (PIETRA QUARZITE)	MRC10032 (MRC10014) • MRC10033 (MRC10015)	10
EVOLUTION 60x60	CAV10240 • CAV10241 • CAV10242	12
LANDSCAPE 90x60	EMI10472 • EMI10473	14
LAVAREDO 90x60	DEL10145	16
LIMESTONE 90x60	MRC10034	18
ONYX & MORE 120x60	CDC10003 • CDC10004 • CDC10005	20
PLIMATECH 120x60	FLO10005 • FLO10006	22
QUARTZ 60x60	CAV10217 • CAV10218	24
QUARTZ 90x60	DEL10126	26
ROCK SALT 60x60	CRM10025 • CRM10026	28
ROYAL STONE 60x60	LAF10112	30
STONEROCK 100x50	CEN10327 • CEN10329 • CEN10356	32
TRACKS 120x60	SIN10049 • SIN10050	34
TWO.0 60x60	CEN10273	36
UNIQUE TRAVERTINE 120x60	PRO10026	38
WALS 60x60	CAV10229 • CAV10237	40

BETONOPTIK

BETONOPTIK

EVOQUE 60x60	SIN10087 • SIN10088 • SIN10089	42
FUSION 60x60	CAV10065 • CAV10066 • CAV10067	44
LAND 60x60	CAV10174 • CAV10175 • CAV10176	46
MATIERES DE REX 120x60	REX10044 • REX10045 • REX10046	48
PAINT 120x60	SIN10072 • SIN10073	50
SEATTLE 60x60	PIA10070 • PIA10071	52

HOLZOPTIK

HOLZOPTIK

NATURAE AEQUA 120x40	CAV10058 • CAV10059 • CAV10060	54
TREVERKHOME 120x40	MAR10926	56
VERO 120x40	MAR11055	58

COTTOOPTIK

COTTOOPTIK

VIGNONI 80x40	DEL10129	60
---------------	----------	----

TERRAZZO OPTIK

TERRAZZO OPTIK

LOMBARDA 60x60	ERG10131	62
----------------	----------	----

VERLEGEARTEN & ZUBEHÖR

ab Seite	64
----------	----

ALWAYS 60x60



CAV10114

LAGERWARE:

BIANCO

59,7x59,7 CAV10113

BEIGE

59,7x59,7 CAV10114

GRIGIO

59,7x59,7 CAV10115

SONDERBESTELLUNG:



120x60



80x80



80x40



Gewicht pro m²



Frostbeständig



V2 Leichtes Farbspiel



Rutschsicherheit



Plattenstärke



Stufenplatte



Sockelleiste

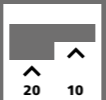

In 2 Stärken erhältlich



Pallettenbesatz



Rektifiziert

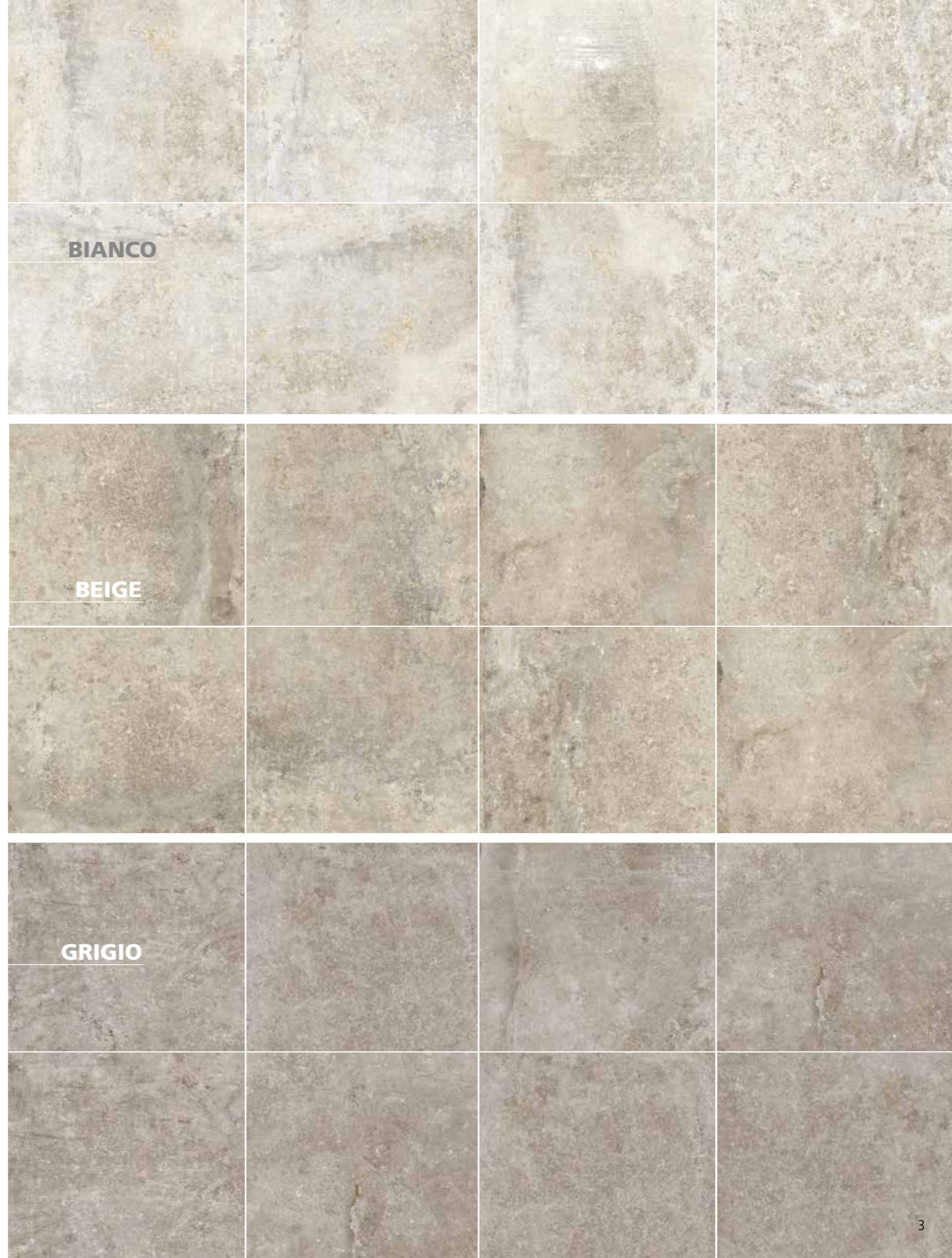

BIANCO

BEIGE

GRIGIO

ATAKAMA 60x60



LAGERWARE:

BEIGE

59,3x59,3

MEI10068

HELLGRAU

59,3x59,3

MEI10069

GREY

59,3x59,3

MEI10070

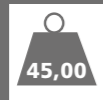

45,00



Frostbeständig



V3 Starkes
Farbspiel



A B
R11

Rutschsicherheit



2cm
Plattenstärke



Stufenplatte



21,00m²
Palettenbesatz



R
Rektifiziert



BEIGE



HELLGRAU

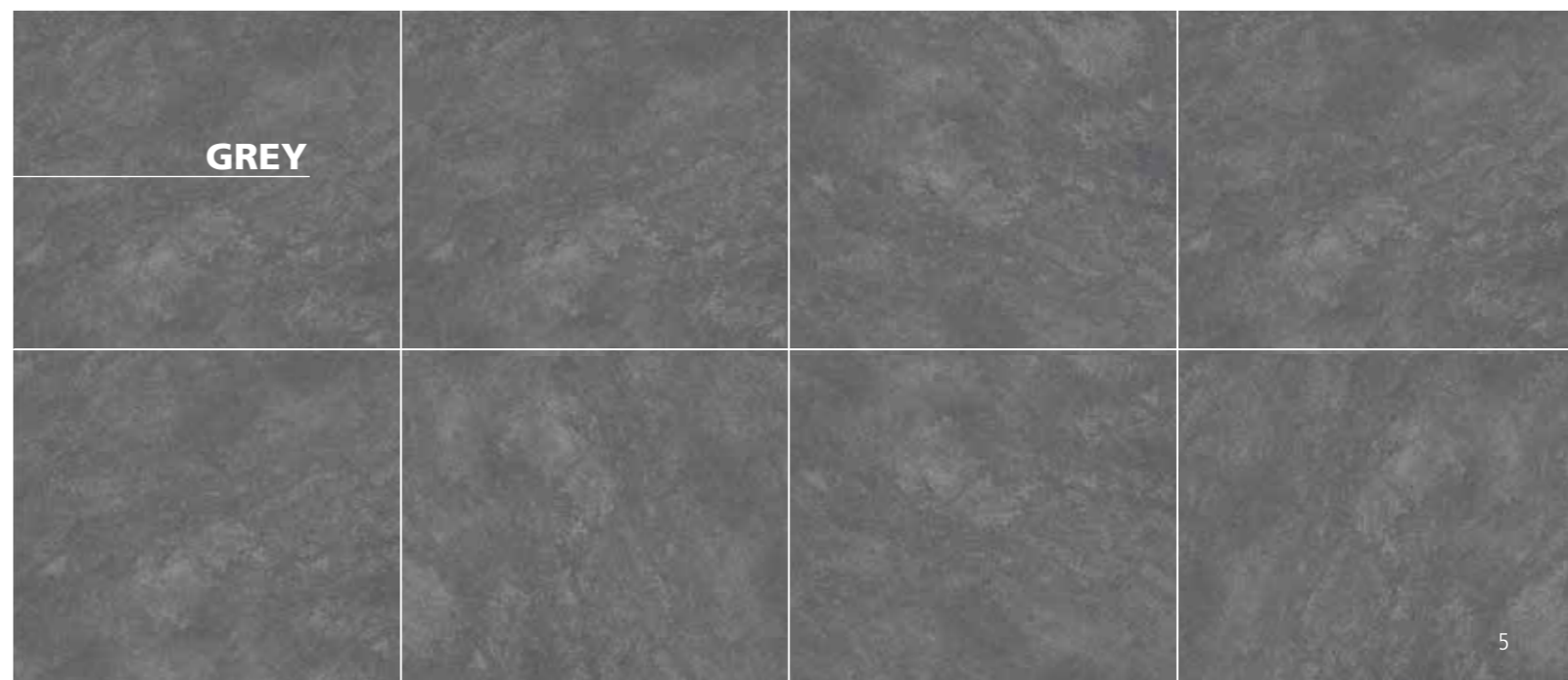

GREY

BOLT 60x60



MEI10087

LAGERWARE:

BEIGE
59,3x59,3 MEI10086

GRAU
59,3x59,3 MEI10087

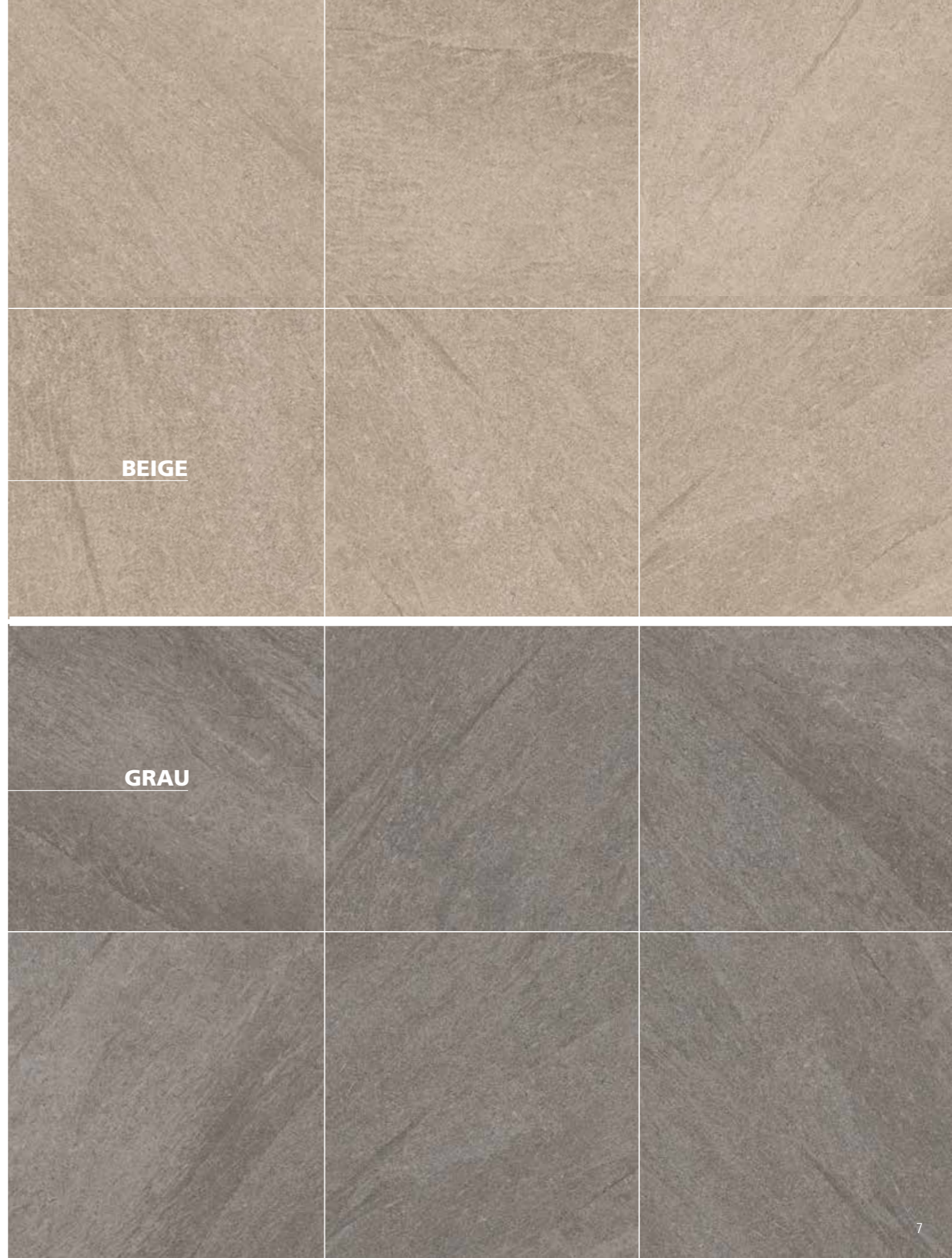

BEIGE

GRAU

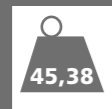

Gewicht pro m²



Frostbeständig



V2 Leichtes
Farbspiel



Rutschsicherheit



Plattenstärke



Stufenplatte



Pallettenbesatz



Rektifiziert

CORNERSTONE 90x45



ERG10122

LAGERWARE:

SLATE MULTICOLOR

89,8x44,8 ERG10101 (ERG10108)

SLATE GREY

89,8x44,8 ERG10122
(ERG10102, ERG10105)

SLATE BLACK

89,8x44,8 ERG10123
(ERG10109, ERG10103)



SLATE MULTICOLOR



SLATE GREY



SLATE BLACK

SONDERBESTELLUNG:



60x60
GREY
BLACK



Gewicht pro m² 44,84 Frostbeständig V3 Starkes Farbspiel R11 Rutschsicherheit Plattenstärke 2cm Stufenplatte Sockelleiste In 2 Stärken erhältlich 19,44m² Pallettenbesatz Rektifiziert

ECLIPSE (PIETRA QUARZITE) 60x60



MRC10032

LAGERWARE:

PULSAR

59,5x59,5 MRC10032 (MRC10014)

LUNAR

59,5x59,5 MRC10033 (MRC10015)



PULSAR

LUNAR



46,64
Gewicht pro m²



Frostbeständig



V3 Starkes
Farbspiel



Rutschsicherheit
R 11



2cm
Plattenstärke



23,04m²
Palettenbesatz



Rektifiziert

EVOLUTION 60x60



CAV10241

LAGERWARE:

GREY

59,7x59,7 CAV10240

SUGAR

59,7x59,7 CAV10241

TITANIUM

59,7x59,7 CAV10242

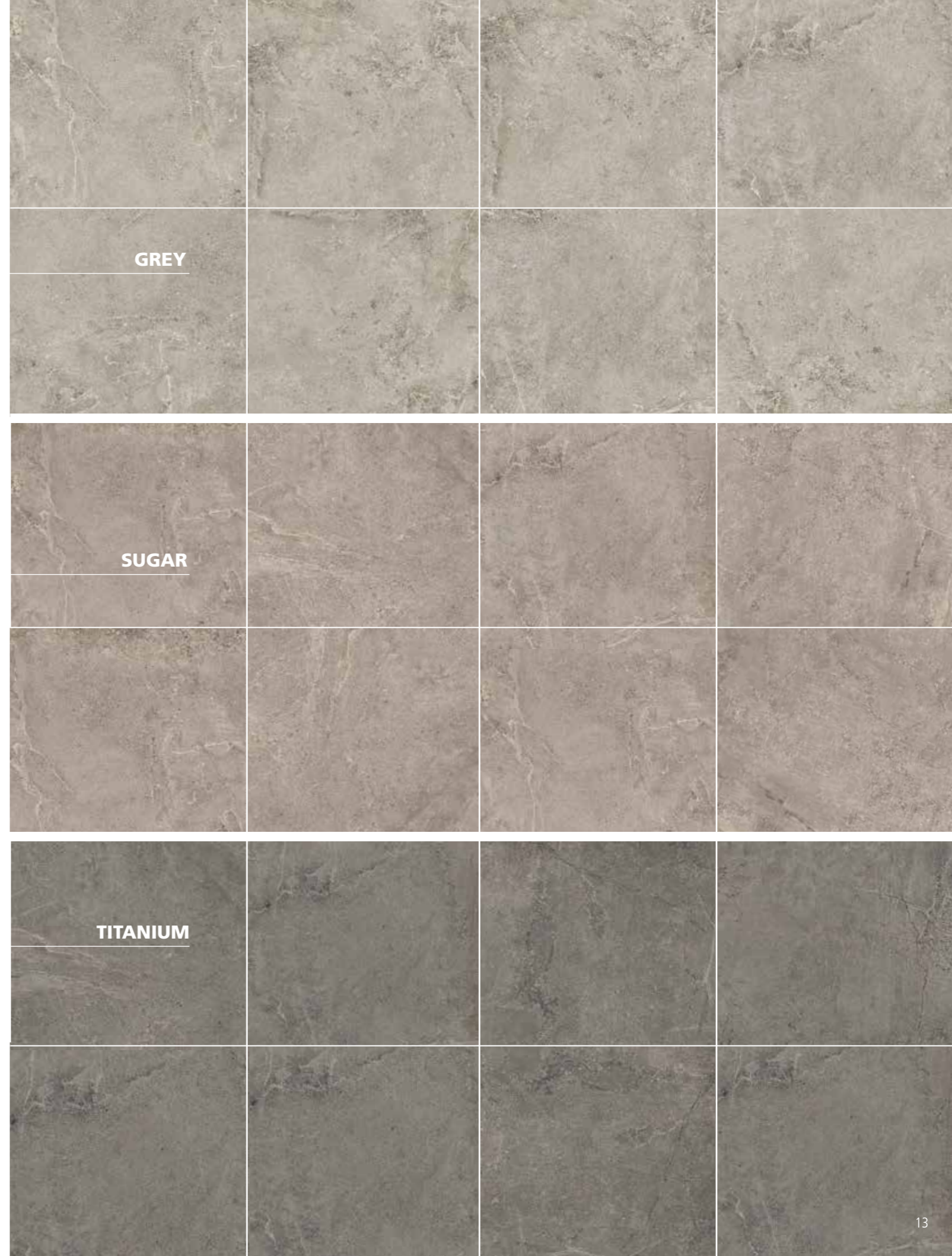

GREY

SUGAR

TITANIUM

SONDERBESTELLUNG:



120x60



100x100

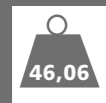

Gewicht pro m²



Frostbeständig



V2 Leichtes Farbspiel



Rutschsicherheit



Plattenstärke



Stufenplatte



Sockelleiste

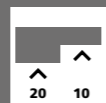

In 2 Stärken erhältlich



23,04m²
Palettenbesatz



Rektifiziert

LANDSCAPE 90x60



EMI10473

LAGERWARE:

SABBIA

89,8x59,8

EMI10472

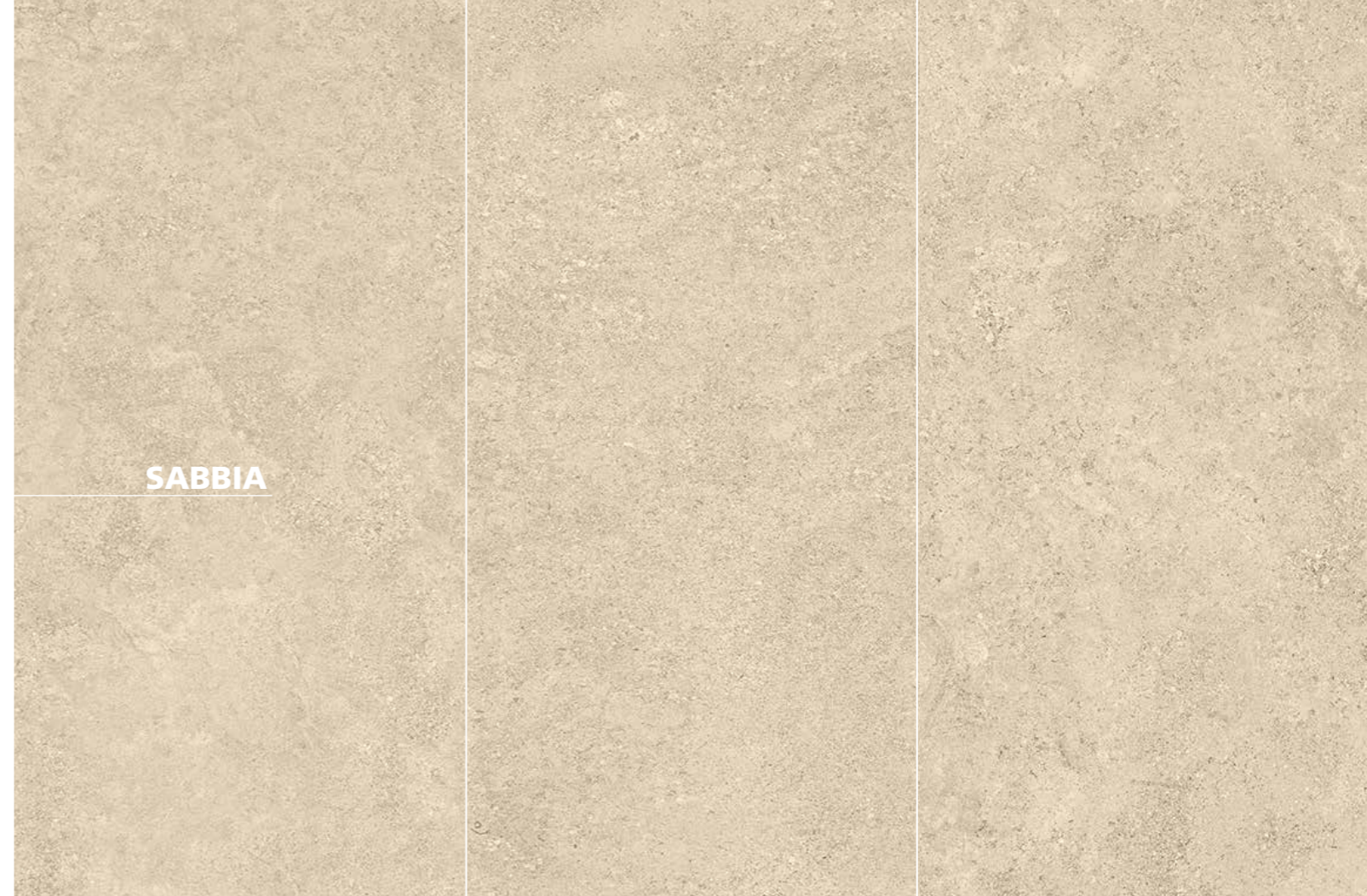

SABBIA

CENERE

89,8x59,8

EMI10473

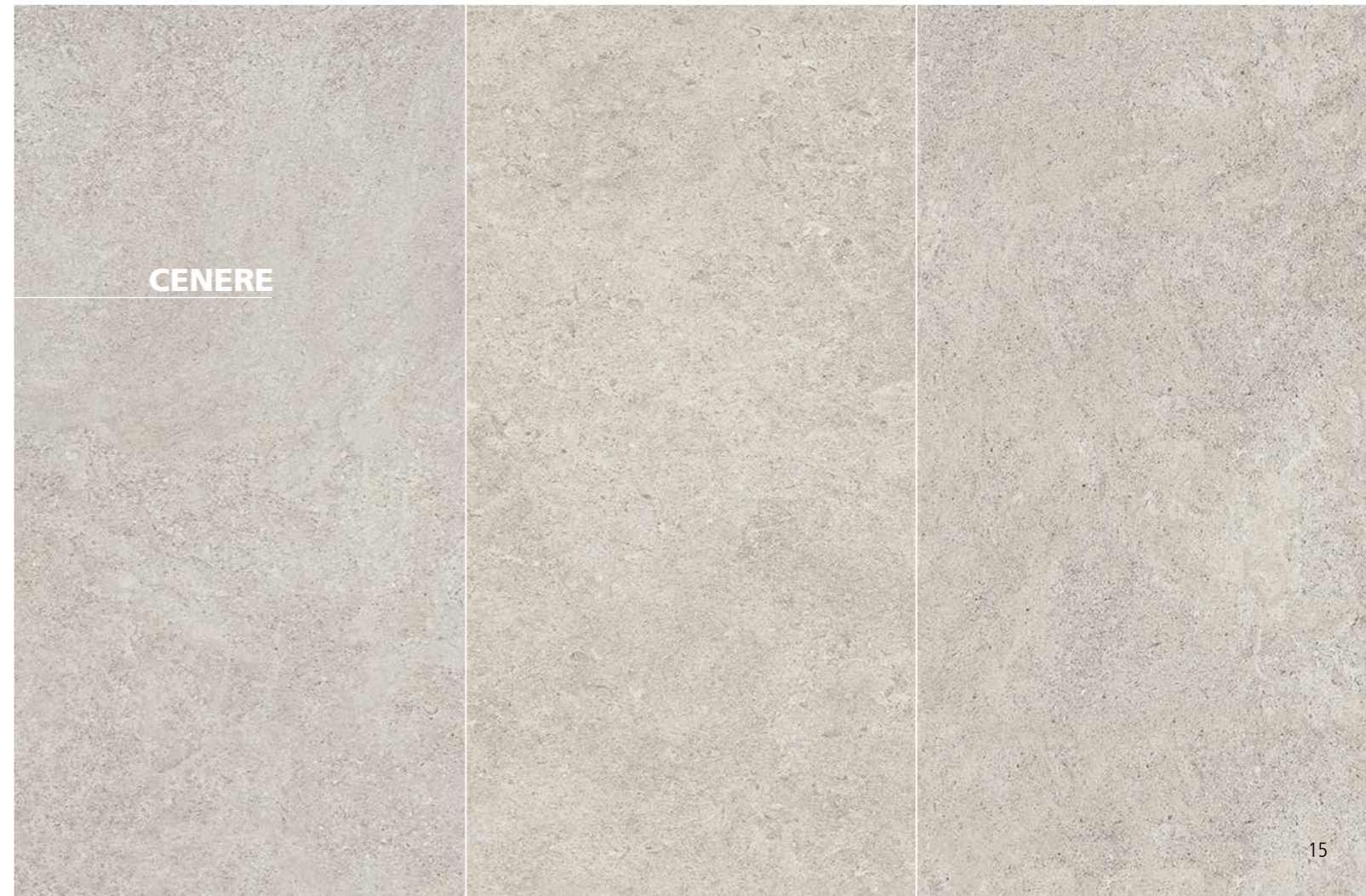

CENERE

SONDERBESTELLUNG:



80x80



60x60



Gewicht pro m²



Frostbeständig



V3 Starkes Farbspiel



Rutschsicherheit



Plattenstärke



Stufenplatte



Sockelleiste

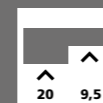

In 2 Stärken erhältlich



Pallettenbesatz



Rektifiziert

LAVAREDO 90x60



DEL10145

LAGERWARE:

NATURAL
89,5x59,6

DEL10145

NATURAL

SONDERBESTELLUNG:

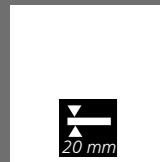

120x120



60x60

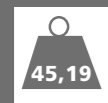

Gewicht pro m²



Frostbeständig



V4 Extrem
starkes Farbspiel



Rutschsicherheit



Plattenstärke



Stufenplatte



Sockelleiste



In 2 Stärken
erhältlich



Pallettenbesatz



Rektifiziert

LIMESTONE 90x60



MRC10034

LAGERWARE:

BEIGE

89,8x59,8

MRC10034

BEIGE

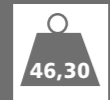

Gewicht pro m²



Frostbeständig



V3 Starkes
Farbspiel



Rutschsicherheit



Plattenstärke



Stufenplatte



Pallettenbesatz



Rektifiziert

ONYX & MORE 120x60



CDC10005

LAGERWARE:

WHITE PORPHYRY

119,7x59,7 CDC10003

GOLDEN PORPHYRY

119,7x59,7 CDC10004

SILVER PORPHYRY

119,7x59,7 CDC10005



WHITE PORPHYRY



GOLDEN PORPHYRY



SILVER PORPHYRY

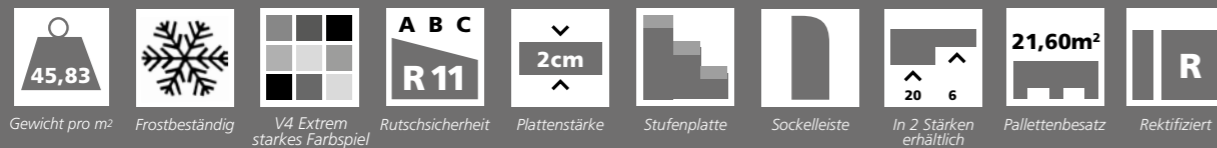

Gewicht pro m²

Frostbeständig

V4 Extrem
starkes Farbspiel

Rutschsicherheit

Plattenstärke

Stufenplatte

Sockelleiste

In 2 Stärken
erhältlich

Pallettenbesatz

Rektifiziert

PLIMATECH 120x60



LAGERWARE:

PLIMAWHITE

119,7x59,7 FLO10005

PLIMABEIGE

119,7x59,7 FLO10006



PLIMAWHITE



PLIMABEIGE



Gewicht pro m²



Frostbeständig



V4 Extremes
Farbspiel



Rutschsicherheit



Plattenstärke



Stufenplatte



Sockelleiste



In 3 Stärken
erhältlich



Pallettenbesatz



Rektifiziert

QUARTZ 60x60 120x60



CAV10209

LAGERWARE:

SILVER

59,7x59,7 CAV10218



Pallettenbesatz



Gewicht pro m²

119,7x59,7 CAV10210(CAV10190)



Pallettenbesatz



Gewicht pro m²

GOLD

59,7x59,7 CAV10217



Pallettenbesatz



Gewicht pro m²

119,7x59,7 CAV10209(CAV10189)



Pallettenbesatz



Gewicht pro m²



Frostbeständig



V3 Starkes
Farbspiel



Rutschsicherheit



Plattenstärke



Stufenplatte



Sockelleiste

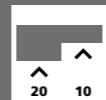

In 2 Stärken
erhältlich



Rektifiziert



SILVER

GOLD

QUARTZ 90x60



DEL10126

LAGERWARE:

GRIGIO

89,5x59,6

DEL10126



GRIGIO

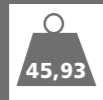

Gewicht pro m²



Frostbeständig



V4 Extremes
Farbspiel



Rutschsicherheit
R 11



Plattenstärke
2cm



Stufenplatte



Pallettenbesatz
27,00m²



Rektifiziert
R

ROCK SALT 60x60 120x60



CRM10025

LAGERWARE:

WHITE GOLD

59,7x59,7

CRM10025



Pallettenbesatz



Gewicht pro m²

119,7x59,7

CRM10027



Pallettenbesatz



Gewicht pro m²

CELTIC GREY

59,7x59,7

CRM10026



Pallettenbesatz



Gewicht pro m²

119,7x59,7

CRM10028



Pallettenbesatz



Gewicht pro m²



Frostbeständig



V4 Extremes
Farbspiel



Rutschsicherheit



Plattenstärke



Stufenplatte



Sockelleiste



In 3 Stärken
erhältlich



Rektifiziert



WHITE GOLD



CELTIC GREY

ROYAL STONE 60x60



LAF10112

LAGERWARE:

GOLD

59,7x59,7

LAF10112

GOLD

SONDERBESTELLUNG:



100x100

- 43,06**
Gewicht pro m²
- Frostbeständig**
- V4 Extrem starkes Farbspiel**
- ABC R11**
Rutschsicherheit
- 2cm**
Plattenstärke
- Stufenplatte**
- Sockelleiste**
- In 2 Stärken erhältlich**
- 21,60m²**
Palettenbesatz
- R**
Rektifiziert

STONEROCK 100x50



LAGERWARE:

WHITE STONE

99,5x49,5 CEN10327

LIGHT STONE

99,5x49,5 CEN10356

ASH STONE

99,5x49,5 CEN10329



WHITE STONE



LIGHT STONE



ASH STONE

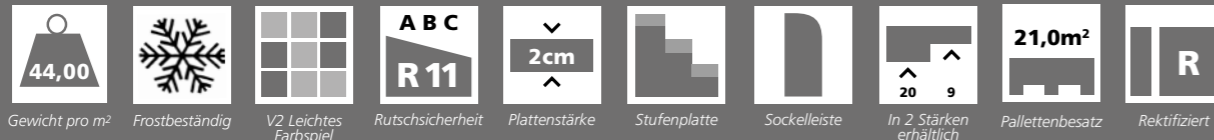

Gewicht pro m² 44,00 Frostbeständig V2 Leichtes Farbspiel ABC R11 Plattenstärke 2cm Stufenplatte Sockelleiste In 2 Stärken erhältlich 21,0m² Pallettenbesatz R Rektifiziert

TRACKS 120x60



LAGERWARE:

SILVER

120,8x60,4 SIN10049



SILVER

SIN10049

SONDERBESTELLUNG:



60x60

GREY

120,8x60,4 SIN10050



GREY

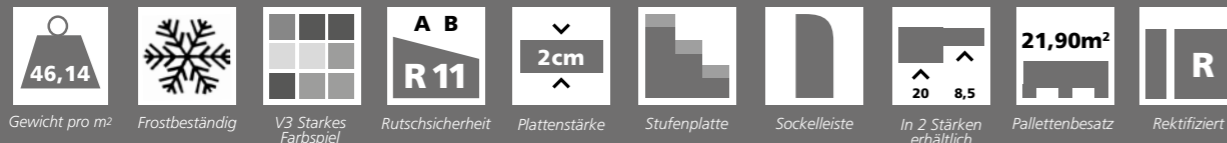

Gewicht pro m² Frostbeständig V3 Starkes Farbspiel R11 Rutschsicherheit Plattenstärke 2cm Stufenplatte Sockelleiste In 2 Stärken erhältlich 21,90m² Pallettenbesatz Rektifiziert

TWO.0 60x60



CEN10273

LAGERWARE:

DESERT NATUR
59,6x59,6 CEN10273

SONDERBESTELLUNG:



50x100 80x80 80x40



UNIQUE TRAVERTINE 120x60



PRO10026

LAGERWARE:

CREAM MINIMAL

119,8x59,8 PRO10026

CREAM MINIMAL



Gewicht pro m²



Frostbeständig



V3 Starkes
Farbspiel



Rutschsicherheit
R11



Plattenstärke
2cm



Stufenplatte



Sockelleiste

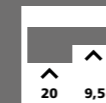

In 2 Stärken
erhältlich



Pallettenbesatz
25,92m²



Rektifiziert

WALS 60x60



CAV10229

LAGERWARE:

GRIGIO

59,7x59,7 CAV10229



GRIGIO

ANTHRAZIT

59,7x59,7 CAV10237



ANTHRAZIT

SONDERBESTELLUNG:



120x60
NUR GRIGIO

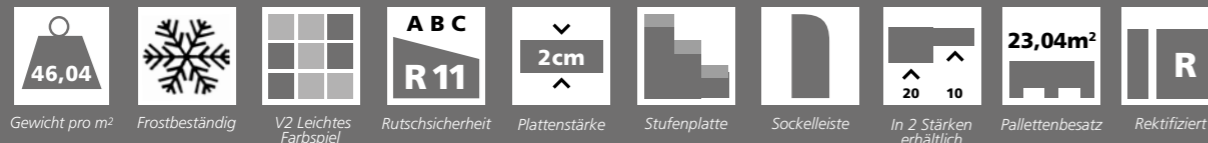

Gewicht pro m²

Frostbeständig

V2 Leichtes Farbspiel

Rutschsicherheit

Plattenstärke

Stufenplatte

Sockelleiste

In 2 Stärken erhältlich

Pallettenbesatz

Rektifiziert

EVOQUE 60x60



SIN10089

LAGERWARE:

SABBIA

60,4x60,4 SIN10089

PERLA

60,4x60,4 SIN10088

GREIGE

60,4x60,4 SIN10087

SONDERBESTELLUNG:

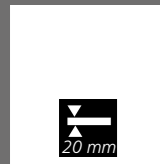

120x120
PERLA
GREIGE



120x60
PERLA
GREIGE

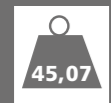

Gewicht pro m²



Frostbeständig



V2 Leichtes
Farbspiel



Rutsicherheit
R11



Plattenstärke
2cm



Stufenplatte



Sockelleiste



In 2 Stärken
erhältlich



Pallettenbesatz
23,36m²



Rektifiziert
R



FUSION 60x60



CAV10065

LAGERWARE:

TORTORA

59,7x59,7

CAV10066

CEMENTO

59,7x59,7

CAV10065

PIOMBO

59,7x59,7

CAV10067

SONDERBESTELLUNG:



80x80



80x40



Gewicht pro m²



Frostbeständig



V1 Farbspiel kaum wahrnehmbar



Rutschsicherheit



Plattenstärke



Stufenplatte



Sockelleiste

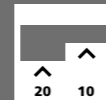

In 2 Stärken erhältlich



Pallettenbesatz



Rektifiziert



TORTORA

CEMENTO

PIOMBO

LAND 60x60



CAV10175

LAGERWARE:

MUDDY

59,7x59,7

CAV10174

IVORY

59,7x59,7

CAV10175

LIGHT GREY

59,7x59,7

CAV10176



MUDDY

IVORY

LIGHT GREY

SONDERBESTELLUNG:



80x80



80x40



Gewicht pro m²



Frostbeständig



V2 Leichtes
Farbspiel



Rutschsicherheit



Plattenstärke



Stufenplatte



Sockelleiste



In 2 Stärken
erhältlich



Pallettenbesatz



Rektifiziert

MATIERES DE REX 120x60



REX10044

LAGERWARE:

SABLE

119,7x59,7 REX10044

NUAGE

119,7x59,7 REX10045

BRUN

119,7x59,7 REX10046



SABLE



NUAGE



BRUN

- 44,81
Gewicht pro m²
- Frostbeständig
- V3 Starkes Farbspiel
- Rutschsicherheit R11
- Plattenstärke 2cm
- Stufenplatte
- Sockelleiste
- In 3 Stärken erhältlich
- 21,60m² Pallettenbesatz
- Rektifiziert

PAINT 120x60



SIN10073

LAGERWARE:

WHITE

120,8x60,4 SIN10072

GREY

120,8x60,4 SIN10073



WHITE

GREY

- 46,76
Gewicht pro m²
- Frostbeständig
- V3 Starkes Farbspiel
- AB R11
Rutschsicherheit
- 2cm
Plattenstärke
- Stufenplatte
- Sockelleiste
- In 2 Stärken erhältlich
- 21,90m²
Palettenbesatz
- R
Rektifiziert

SEATTLE 60x60



PIA10071

LAGERWARE:

BEIGE

59,8x59,8

PIA10071

GRAU

59,8x59,8

PIA10070

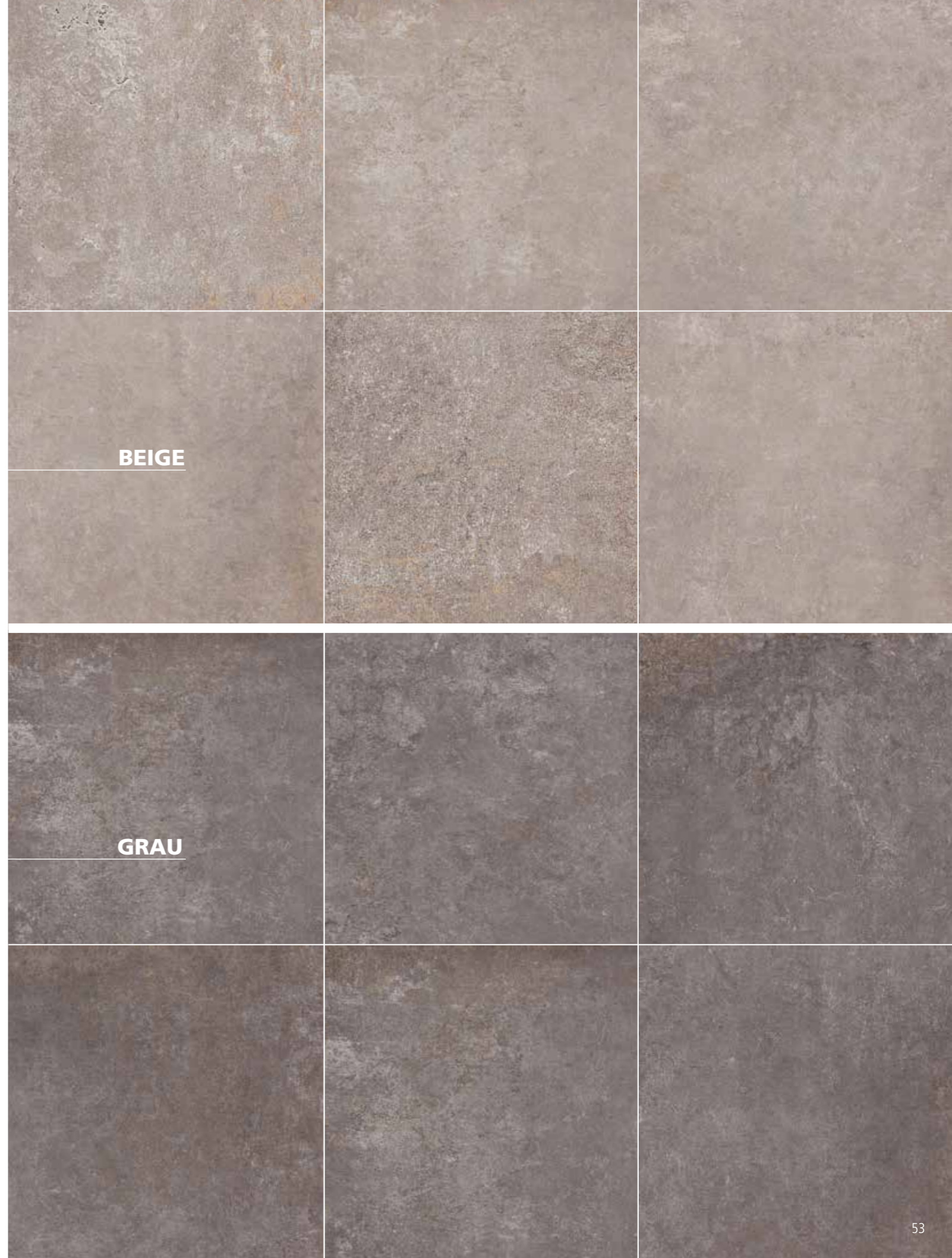

BEIGE

GRAU



Gewicht pro m²



Frostbeständig



V3 Starkes
Farbspiel



Rutschsicherheit



Plattenstärke



Stufenplatte



Pallettenbesatz



Rektifiziert

HOLZ OPTIK **NATURAE AEQUA** 120x40 60x60



CAV10058

LAGERWARE:

CIRRUS

119,7x39,7 CAV10058



Pallettenbesatz



Gewicht pro m²

SILVA

119,7x39,7 CAV10059



Pallettenbesatz



Gewicht pro m²

TUR

119,7x39,7 CAV10060



Pallettenbesatz



Gewicht pro m²

59,7x59,7 CAV10056



Pallettenbesatz



Gewicht pro m²

SONDERBESTELLUNG:



160x30



60x60



Frostbeständig



V3 Starkes Farbspiel



Rutschsicherheit



Plattenstärke



Stufenplatte



Sockelleiste

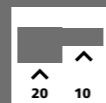

In 2 Stärken erhältlich



Rektifiziert



CIRRUS



SILVA



TUR

TREVERKHOME 120x40



MAR10926

LAGERWARE:

LARICE

119,5x39,6

MAR10926

LARICE

SONDERBESTELLUNG:



60x60

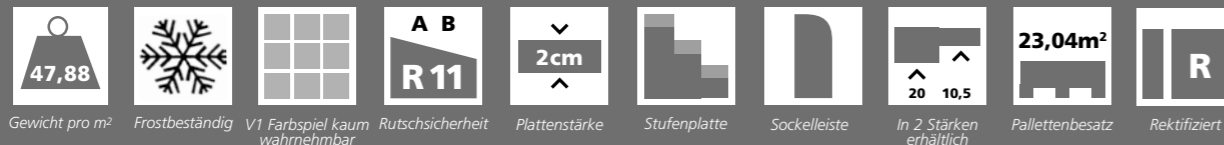

VERO 120x40



LAGERWARE:

ROVERE
119,5x39,6 MAR11055

ROVERE

MAR11055

SONDERBESTELLUNG:



60x60

- 45,83
Gewicht pro m²
- Frostbeständig
- V3 Starkes Farbspiel
- Rutschsicherheit
- 2cm
Plattenstärke
- Stufenplatte
- Sockelleiste
- In 2 Stärken erhältlich
- 23,04m²
Pallettenbesatz
- R
Rektifiziert

VIGNONI 80x40



DEL10129

LAGERWARE:

COTTO

79,5x39,6

DEL10129

SONDERBESTELLUNG:



60x60



Gewicht pro m²

Frostbeständig

V4 Extremes
Farbspiel

Rutschsicherheit

Plattenstärke

Stufenplatte

Sockelleiste

In 2 Stärken
erhältlich

Pallettenbesatz

Rektifiziert

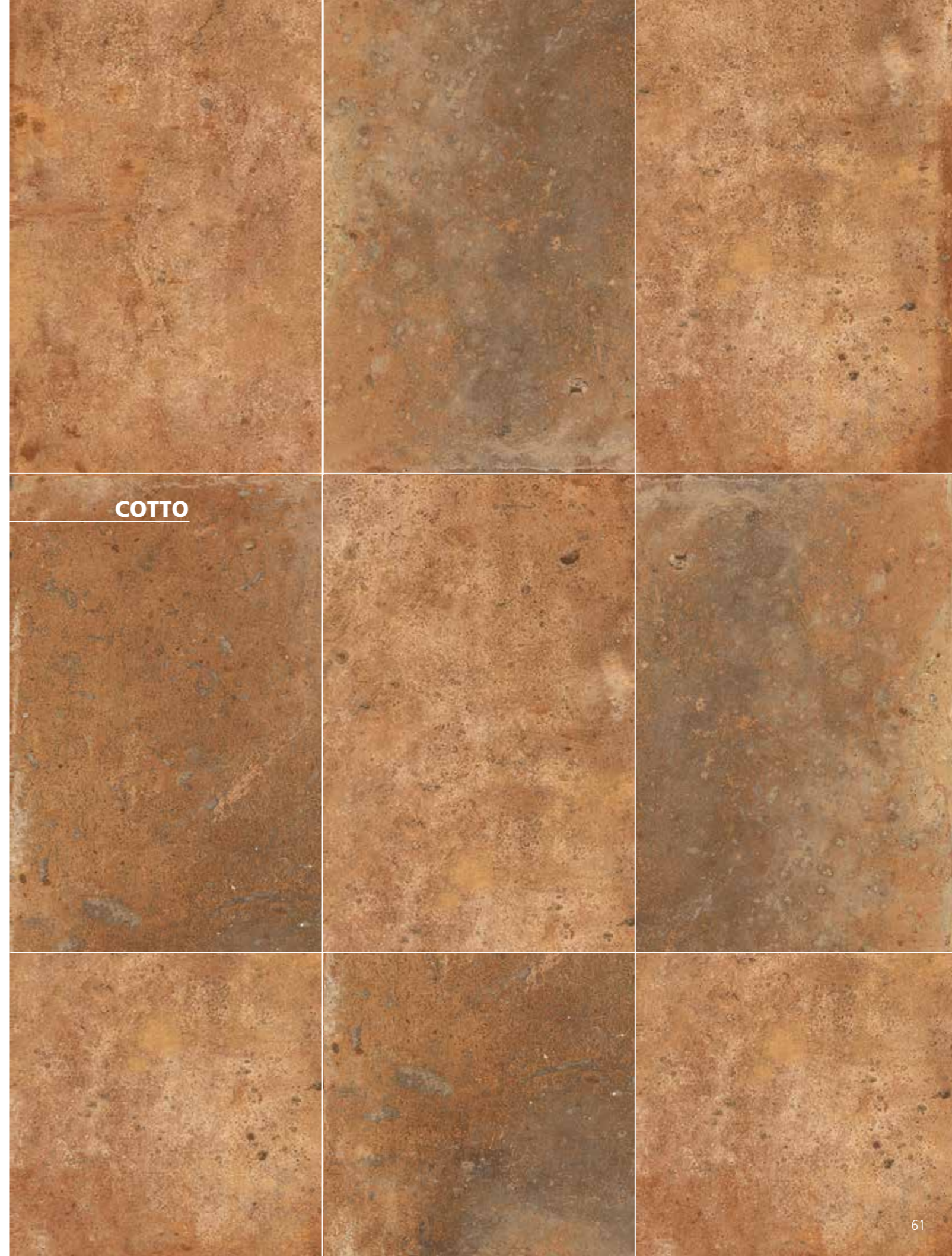

COTTO

LOMBARDA 60x60



ERG10131

LAGERWARE:











GRIGIO

59,8x59,8

ERG10131



GRIGIO

- 
46,00
Gewicht pro m²
- 
Frostbeständig
- 
V3 Starkes Farbspiel
- 
Rutschsicherheit
- 
Plattenstärke
- 
Stufenplatte
- 
Sockelleiste
- 
In 2 Stärken erhältlich
- 
23,04m²
Pallettenbesatz
- 
Rektifiziert

TerraMaxx DS

Erstes kapillarpassives Drain-Stelzlager-System für die feste, aufgestellte Verlegung selbsttragender Platten im drainfähigen Bettungsmörtel

- Keine wackelnden Beläge
- Sicherer Einsatz auch bei Stauwasser auf der Abdichtung



ARD10429 Gutjahr System MorTec Soft zementgrau
ARD10428 Gutjahr System MorTec Soft steingrau



GUT10112 Gutjahr System TerraMax DS Drainagestelzlager 22 x 22
ARD10262 Microtec Großformatkleber In- u. Outdoor"



GUT10107 Fugenfix Typ TS 100 Stk./Pkg
GUT10106 Fugenfix Typ XS 100 Stk./Pkg

DRAINAGERINNE



SCD10530
 2 x 7,5 x 200 cm
 Edelstahl gelocht

REINIGUNG & PFLEGE



LITHOFIN MN
 Außenreiniger
 Für alle Keramikbeläge.

LIT10030



LITHOFIN ALEX
 Der Grünbelag-Entferner.

LIT10020

2 cm-Platten-System

Dauerhafte, stabile Verlegung von 2 cm-Feinsteinzeug-Platten in der gebundenen Bauweise auf Balkon und Terrasse



feinste Bauchemie

Untergrund	Abdichtung	Drainage	Mörtelbett	Haft- und Kontaktbrücke	Verfugung¹⁾
Beton – mit GD 749 Grundierung	TDS 823 TurboDichtSchlämme 2-K, DSF RS 623 DichtSchlämme Flex RS	DRM 653 DrainageMatte	Dünnschichtiger Aufbau mit BH 869 BauHarz und DEK 872 Drainage-EstrichKorn (mind. 2,5 cm) oder DM 610 DrainageMörtel (mind. 5 cm)	MEG 665 megaFlex S2	FL plus® FlexFuge plus, Quattrotec Dichtstoff matt

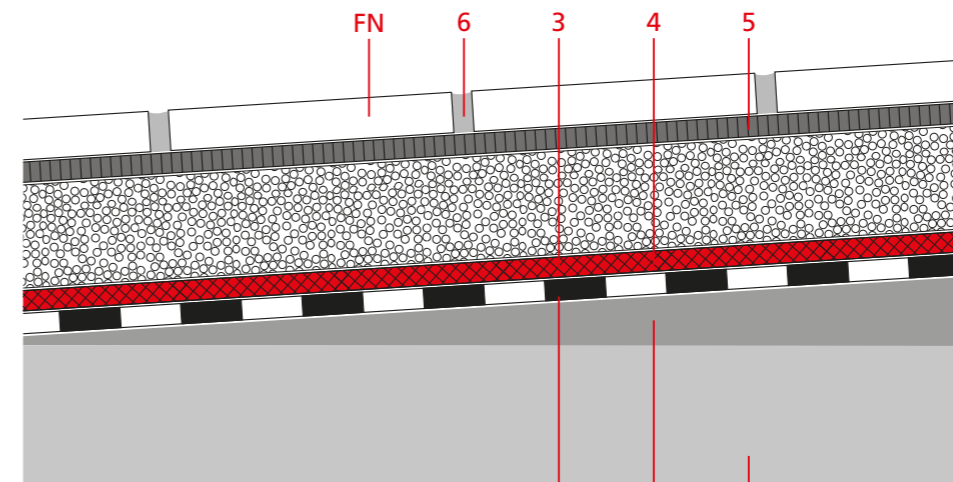

- 1 Gefällespachtel
- 2 Abdichtung
- 3 Drainagematte
- 4 Drainagemörtel (mind. 5 cm dick)
- 5 Haft- und Kontaktbrücke
- 6 Zementärer, flexibler Fugenmörtel bzw. elastischer Fugenmörtel
- B Beton
- FN Fliese oder Naturstein

Weitere Informationen zu möglichen Verlegesystemen finden Sie unter www.sopro.at oder fragen Sie Ihren Fliesenleger-Meisterbetrieb.

Fugenfarben²⁾

FL plus® FlexFuge	
betongrau 14	grau 15
silbergrau 17	sandgrau 18
steingrau 22	jurabeige 33
bahamabeige 34	balibraun 59
basalt 64	anthrazit 66
schwarz 90	
Quattrotec Dichtstoff matt	
grau 15	silbergrau 17
zementgrau 20	steingrau 22
beige 32	jurabeige 33
anthrazit 66	manhattan 77

¹⁾ Produktauswahl abhängig vom zu verlegenden Belagsmaterial und Format.
²⁾ Aus drucktechnischen Gründen können die gezeigten Farbtöne vom ausgehärteten Material abweichen.

LOSE VERLEGUNG



- STABILES GEFÜGE
- Sehr schmale Fuge möglich
- Praktische Verlegung
- Geringes Gewicht
- Geringe Aufbauhöhe
- Nachjustieren mittels Einstellschlüssel
- Bei schwierigen Bausituationen einsetzbar
- Keine Dehnfugen notwendig

AUF STELZLAGER CA. MENGENBEDARF

Stelzlageranzahl pro m²

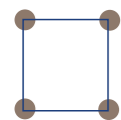

60x60
2.8-3.5/m²

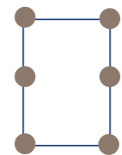

60x90
3.5-4.5/m²

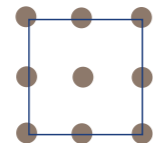

100x100
6.25-6.9/m²

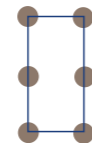

45x90
4.8-5.2/m²

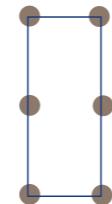

50x100
3-3.9/m²

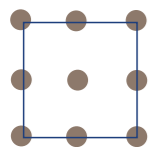

80x80
6.25-6.9/m²

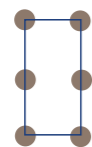

40x80
6.3-6.8/m²

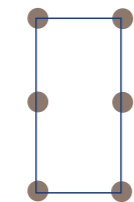

60x120
2.8-3.5/m²

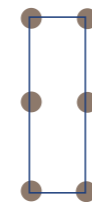

40x120
4.16-4.9/m²

STELZLAGER

STELZLAGER
IN 10ER
VERPACKUNG

KING LORD
Fixe Höhe



DPS10042
8 mm fixe Höhe
(1 Kar. = 100 Stk.)



DPS10043
Verl. 4mm Höhe
(1 Kar. = 100 Stk.)



DPS10044
Lucky Nivellierungs-/
Ausgleichsblätter
1,5/2,5mm
(1 Kar. = 200 Stk.)

KING STELZLAGER

selbstnivellierend und fix zum Umschalten



DPS10037
30 - 41 mm
(1 Kar. = 10 Stk.)

DPS10038
41 - 63 mm
(1 Kar. = 10 Stk.)

DPS10039
63 - 95 mm
(1 Kar. = 10 Stk.)

DPS10040
95 - 152 mm
(1 Kar. = 10 Stk.)

DPS10041
152 - 209 mm
(1 Kar. = 10 Stk.)

DPS10030
Verlängerung 113mm
(1 Kar. = 10 Stk.)

QUEEN STELZLAGER FIX

optional mit Einlegeplatte selbstnivellierend
individuelle Fugenbreiten (4mm, 3mm, 2mm) möglich

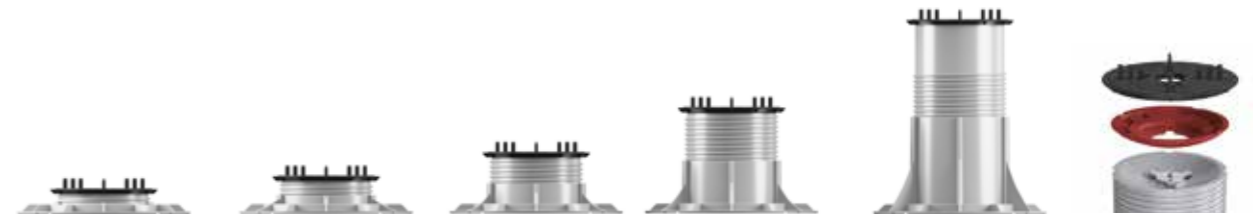

DPS10031
21 - 30 mm
(1 Kar. = 10 Stk.)

DPS10032
29 - 44 mm
(1 Kar. = 10 Stk.)

DPS10033
43 - 72 mm
(1 Kar. = 10 Stk.)

DPS10034
70 - 126 mm
(1 Kar. = 10 Stk.)

DPS10035
124 - 234 mm
(1 Kar. = 10 Stk.)

DPS10036
Einlegeplatte (rot)
(1 Kart. = 50 Stk.)

ZUBEHÖR



DPS10017
King-Pad
Schutz für
Abdichtung glatt
(1 Kart. = 20 Stk.)

DPS10016
King-Klip Up -
obere Klammer
für Stufe
(1 Kart. = 20 Stk.)

DPS10018
King-Klip Down -
untere Klammer
für Stufe
(1 Kart. = 20 Stk.)

DPS10019
King-Klip Wall
Klammer für
Wandabschluss
(1 Kart. = 40 Stk.)

DPS10045
Einstellschlüssel
bestehend aus
2 Elementen
(Griff & Kupplung)

Abgabe nur in vollen Sets / Kartons möglich

SCHIENENSYSTEM

TRIAS ALU VERSCHRAUBT



TRIAS STELZLAGER MIT SCHIENENSYSTEM

					
TRI10025 10 - 20 mm (1 Kar. = 10 Stk.)	TRI10007 18 - 27 mm (1 Kar. = 10 Stk.)	TRI10008 36 - 60 mm (1 Kar. = 10 Stk.)	TRI10009 60 - 115 mm (1 Kar. = 10 Stk.)	TRI10027 115 - 220 mm (1 Kar. = 10 Stk.)	
					
TRI10000 Basisprofil 5,1x5,5 cm / 2,4 lfm	TRI10002 Connector L-Längs (1 Set = 4 Stk.)	TRI10003 Connector Q-Quer (1 Set = 8 Stk.)	TRI10004 Connector Q Flex (1 Set = 5 Stk.)	TRI10023 Connector Corner (1 Set = 2 Stk.)	
					
TRI10026 Basisprofil Slim 2,5x5,5 / 2,4 lfm	TRI10005 Slim Connector L-Längs (1 Set = 8 Stk.)	TRI10006 Slim Connector Q-Quer (1 Set = 16 Stk.)	TRI10029 Slim Connector Q-Flex (1 Set = 10 Stk.)	TRI10020 Soft Tape 10 m/Rolle (1 Set = 5 Rollen)	TRI10018 Multiclip X (1 Set = 50 Stk.)

TRIAS ZUBEHÖR

					
TRI10036 Pad (1 Set. = 30 Stk.)	TRI10024 Folienschutz Pad Alu kaschiert (1 Set. = 30 Stk.)	TRI10016 Unterlags Pad 3mm 60 x 90 mm (1 Set. = 60 Stk.)	TRI10017 Unterlags Pad 8mm 60 x 90 mm (1 Set. = 24 Stk.)	TRI10011 Verlängerung 25 mm (10 Stk. / Karton)	TRI10012 Verlängerung 50 mm (10 Stk. / Karton)
					
TRI10021 Fliesenabschluss- blech oben (1 Set. = 5 Stk.)	TRI10022 Fliesenabschluss- blech unten (1 Set. = 5 Stk.)	TRI10031 Fliesenanschlag Metall (1 Set = 10 Stk.)	TRI10014 Adapterclip (1 Kar. = 30 Stk.)		

Abgabe nur in vollen Sets / Kartons möglich

TRIAS WABIC

VOLLFLÄCHIGE UNTERKONSTRUKTION



VORTEILE

- Effektiver Durchbruchschutz
- Verhindert Kippen der Platten
- Höhere Festigkeit für den Belag
- Dämpft Trittschall
- Leichte Bearbeitung der Boards
- Uneingeschränkte Möglichkeiten für Verlegemuster und Plattengrößen (als bei Stelzlager und Schienensysteme)
- Höhe verstellbar, auch nach Verlegung der Boards per Steckschlüssel
- Witterungsbeständig, UV-stabil
- Nachhaltig aus 100% recycelten Kunststoff
- Schnelle und einfache Verlegung (Werkzeuglos)
- Gleichmäßige Auflagefläche
- Leichte Bearbeitung der Boards
- Mengenermittlung mit TRIAS - Konfigurator



WABIC BOARD

TRI10032

(8 Stk. / Karton)

Durchbruchschutz in Wabenstruktur
60 x 40 cm, Höhe 4,8 cm



WABIC CONNENTOR - CLIP

TRI10037

(50 Stk. / Karton)

Zur Verbindung der Wabic Boards



WABIC X - PAD Fugenabstandhalter

TRI10033

2mm Fugenbreite
(30 Stk. / Karton)

TRI10034

3mm Fugenbreite
(30 Stk. / Karton)

TRI10035

4mm Fugenbreite
(30 Stk. / Karton)



WABIC STELZLAGER

TRI10040

19 - 27 mm
(10 Stk. / Karton)

TRI10041

27 - 40 mm
(10 Stk. / Karton)

TRI10042

40 - 64 mm
(10 Stk. / Karton)

TRI10043

64 - 110 mm
(10 Stk. / Karton)

TRI10044

110 - 202 mm
(10 Stk. / Karton)

TRI10045

202 - 302 mm
(10 Stk. / Karton)



WABIC ADD - ON - ADAPTER

TRI10039

(30 Stk. / Karton)

Verbindung zwischen Stelzlager und Wabic Board



WABIC FIX - CLIP

TRI10038

(30 Stk. / Karton)

Zum Fixieren von Anschlagteilen wie z. B. Fliesenanschlag und Abschlußblech



WABIC STELUFUSSVERLÄNGERUNG

TRI10046

100 mm
(10 Stk. / Karton)

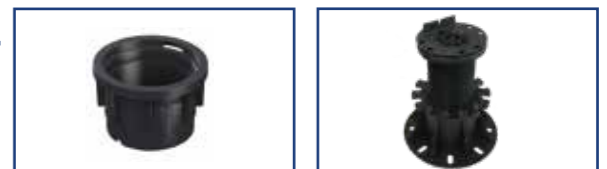

TRIAS ZUBEHÖR

TRI10021

Fliesenabschlussblech oben
(1 Set. = 5 Stk.)

TRI10022

Fliesenabschlussblech unten
(1 Set. = 5 Stk.)

TRI10031

Fliesenanschlag Metall
(1 Set. = 10 Stk.)

TRI10047

Wabic Einstellschlüssel

TRI10024

Folienschutz Pad Alu kaschiert
(1 Set. = 30 Stk.)

TRI10036

Pad
(1 Set. = 30 Stk.)



TERRASSENPROFILE

(EDELSTAHL 3D-POLIERT UND K220-GESCHLIFFEN)

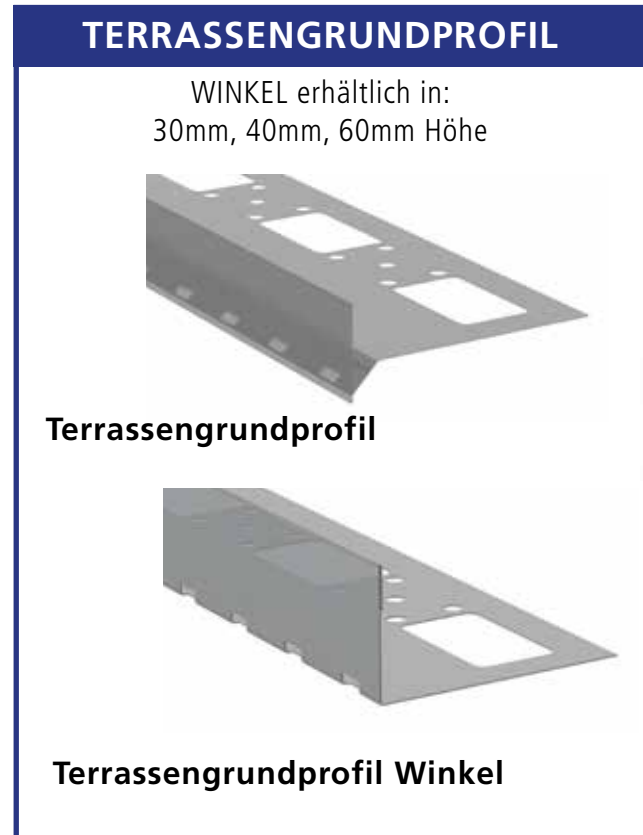
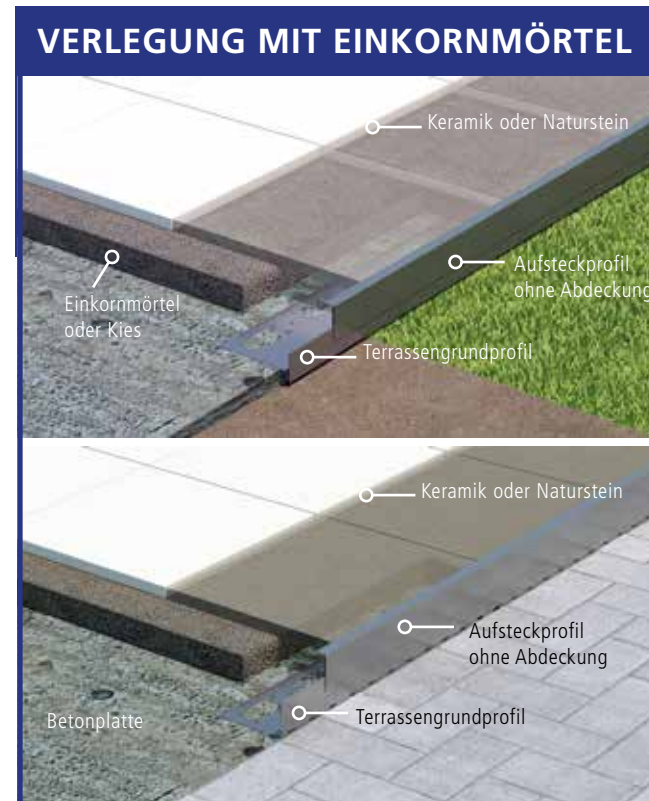
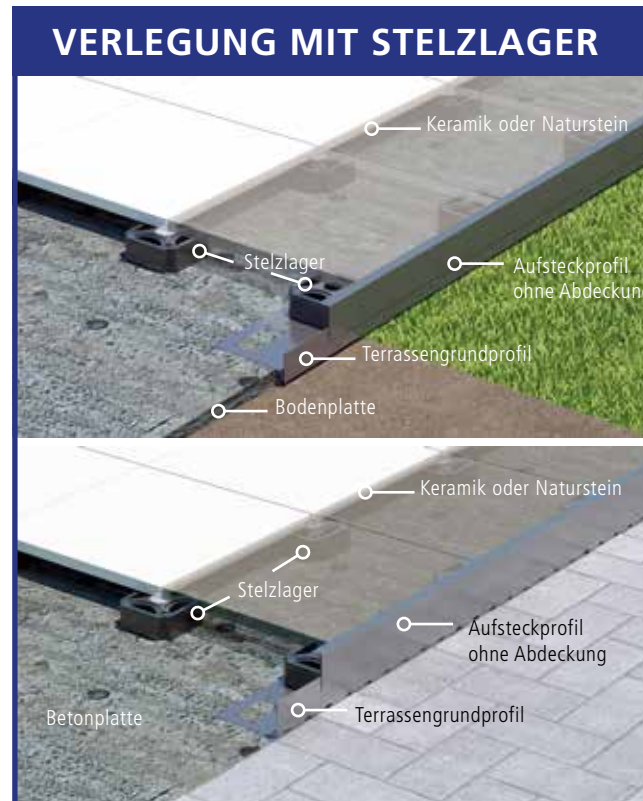

STUFEN & POOLUMRANDUNGEN

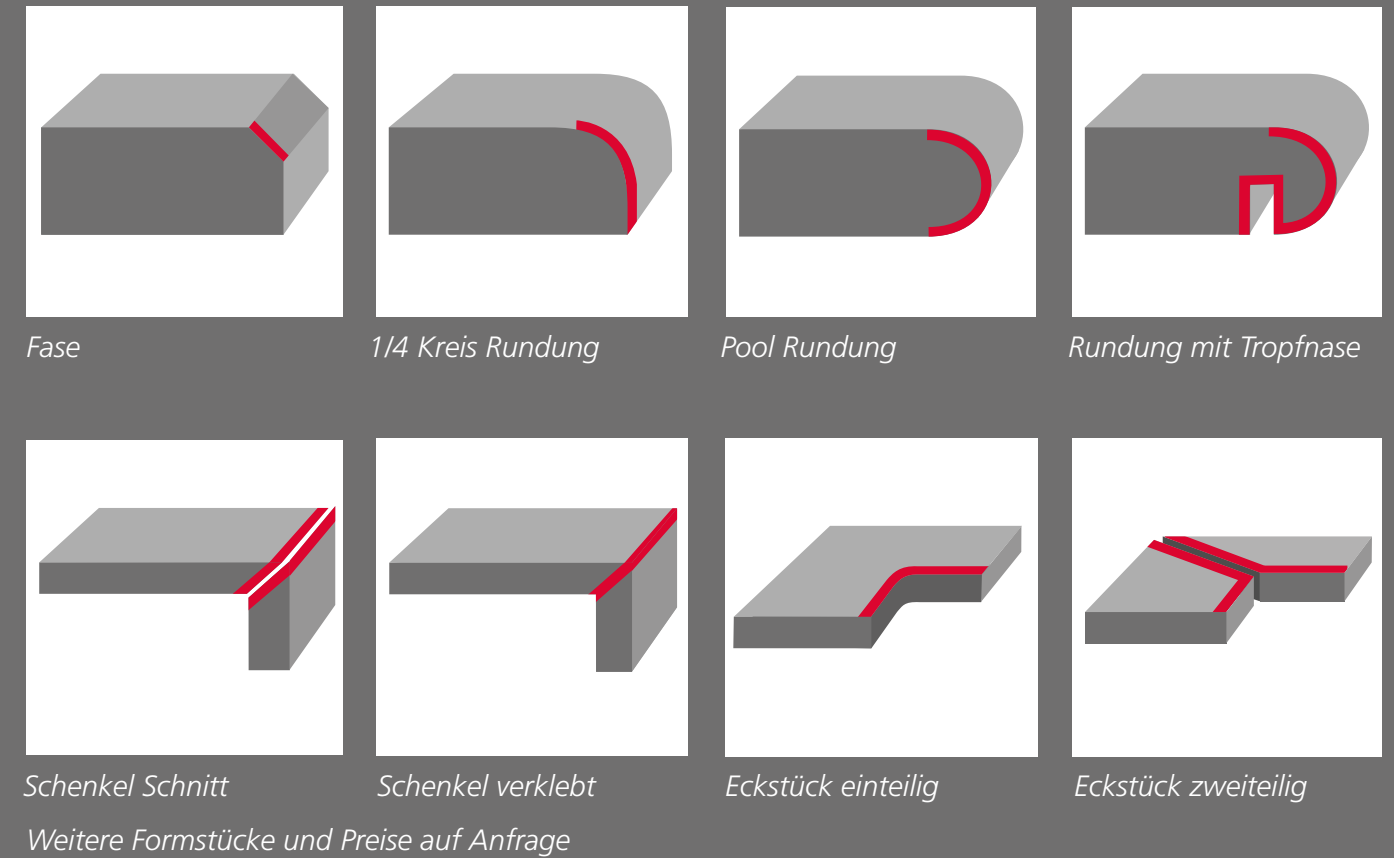

Beispiel Poolumrandung 8x4m: 1/4 Kreis gerundet. 4 x Eckstück einteilig, Skimmerausschnitt.



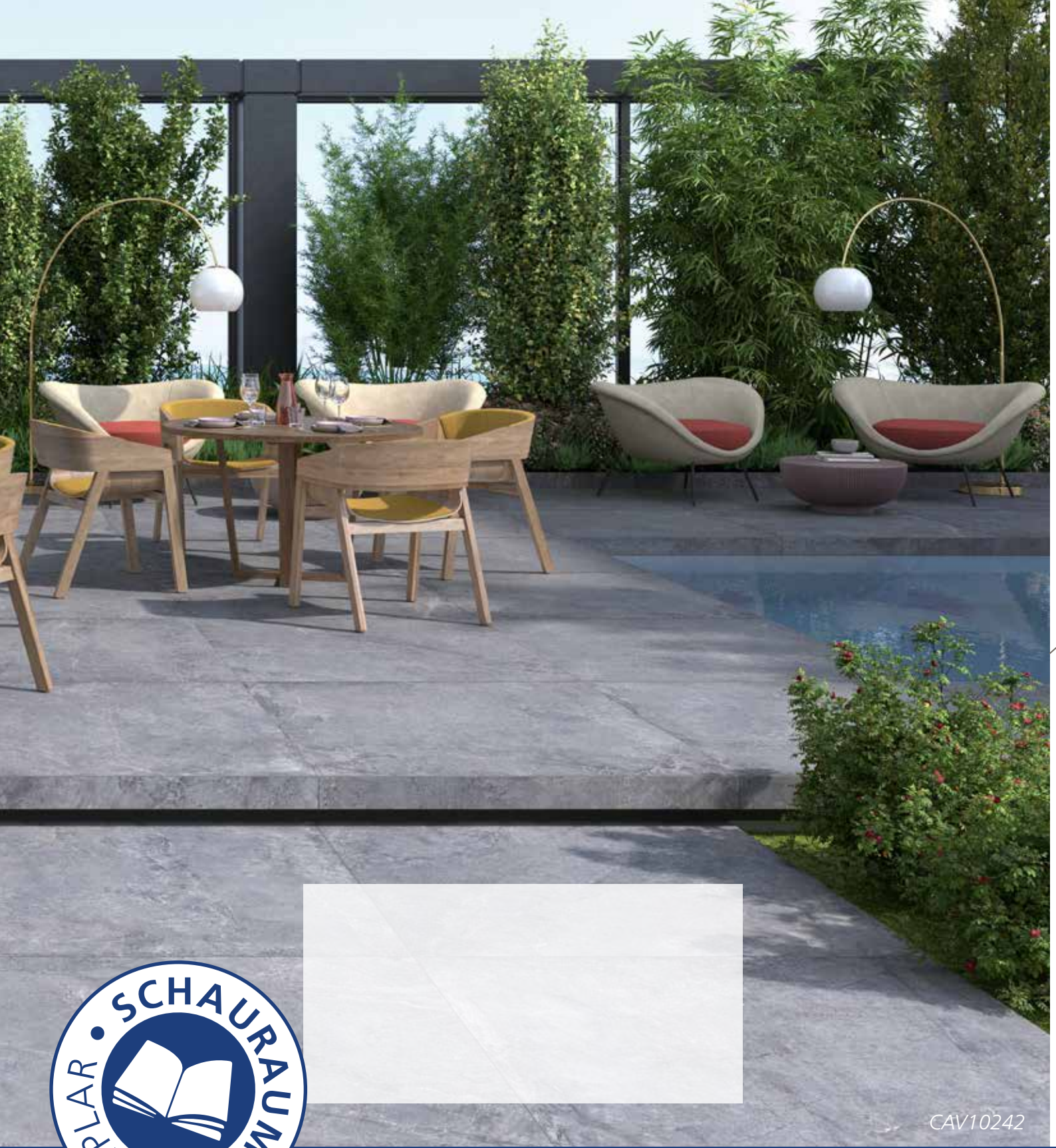

CAV10242



FLIESENINFO

Fliesenideen für alle Bereiche